

Kadee O Gauge Couplers

June 2012

- No. 740 - Metal Coupler - METAL Gear Box
- No. 742 - Metal Coupler - Plastic Gear Box
- No. 743 - Metal Coupler - Plastic Gear Box
- No. 745 - Metal Coupler - Plastic Gear Box
- No. 746 - Metal Coupler - Plastic Gear Box
- No. 747 - Metal Coupler - Plastic Gear Box

(the 805 has been replaced by the number 740 & 745)

Only the configurations with code numbers are currently available. Faded configurations are not currently available

**Fixing holes 2.1mm approx.
Gear box is approx 5mm thick.**

**Recommended Screws
Kadee No. 1688 (1-72 x 3/8") or
Self taperer ST35 9.5mm**

www.7mm.co

The Knuckle and trip pin should always be at the same height as determined by the height gauge. The shank and gear box vary as shown by the chart.

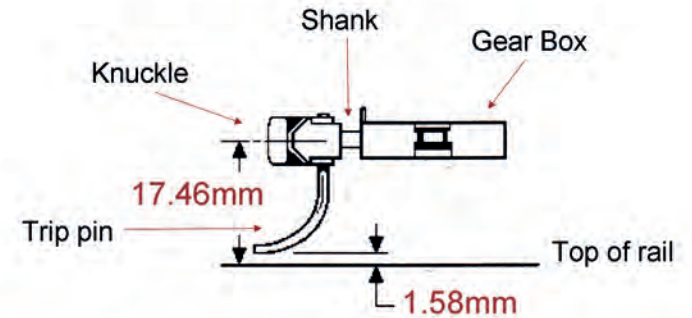

Short Underset Shank

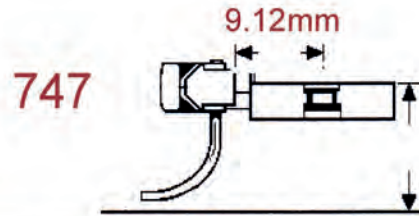

747

Medium Underset Shank

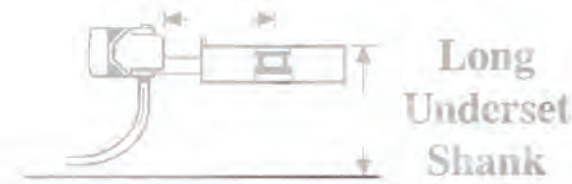

Long Underset Shank

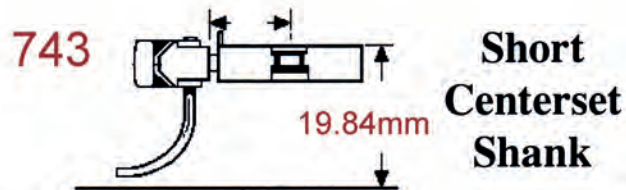

743

Short Centerset Shank

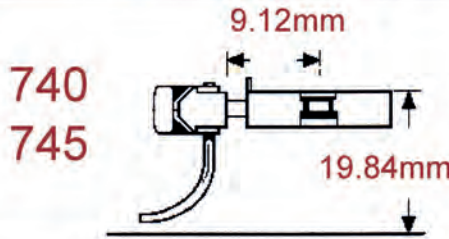

740
745

Medium Centerset Shank

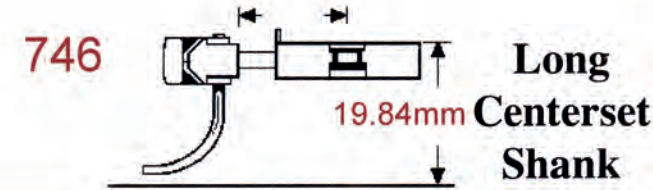

746

Long Centerset Shank



Short Overset Shank

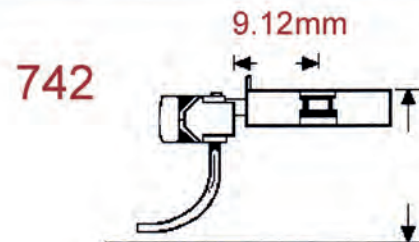

742

Medium Overset Shank

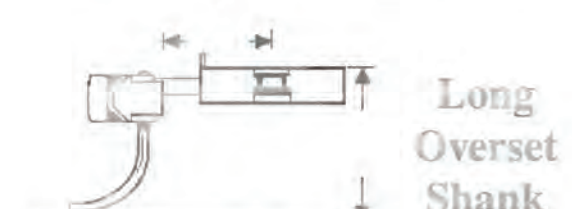

Long Overset Shank